



THE NAME OF
EXCELLENCE

CREATED FOR DESIRE
LEATHER BELTS



MANWELL INDUSTRY



THE NAME OF
EXCELLENCE

About Us:

Manwell Industry is a reliable manufacturers and supplier of Sports Gear, Sports Wear, Fitness Wear, Garments, Summer Wear, Leather Collections, Work Wear.

OUR MISSION STATEMENT:

We want to create a product that is more than just a logo on a piece of Apparels. We want it to be meaningful and worn with pride which is actually useful on and off the fitness ground.

THE MANWELL GUARANTEE:

Here at Manwell Industry, we pride ourselves on our cutting edge designs using the latest textile material. This constant innovation ensures that all of our products, and the people wearing them, achieve their maximum potential, and give their best performance.

HIGHLIGHTS

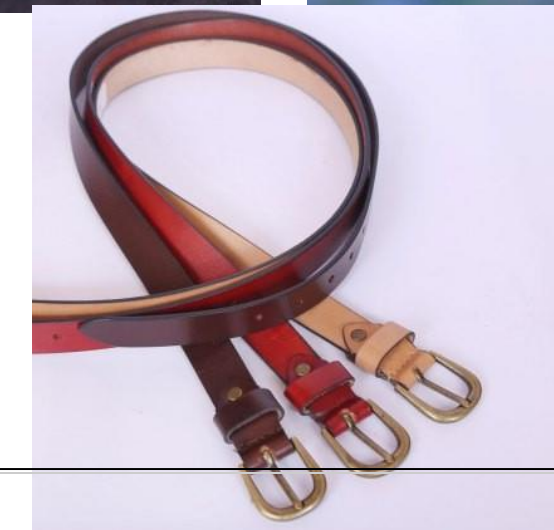

CONTACT INFORMATION

Address:

Pakistan: Mohallah Muhammad Pura PO Khas Ugoki/Sialkot/Pakistan

Turkiye: Zafer Mahallesi, Gümüş Sk. No:2 Kat:5, 34197Yenibosna /Bahçelievler/Istanbul/Turkey

Mobile: +92-335-1681198

Email: info@manwellindustry.com

Email: manwellindustry@gmail.com

Web: www.manwellindustry.com



MENS CASUAL



MI-1338

- 35mm Casual Belt.
- Hand Made
- Hand Finished with Natural wax for wax breaking effect.
- Full Grain Veg Tanned Leather



MI-1339

- 35mm Casual Belt
- Hand Made
- Twin Colour
- Full Grain Veg Tanned Leather



www.manwellindustry.com

L E A T H E R B E L T S



MI-1341

- 35mm Casual Belt.
- Hand Made
- Hand Finished with Natural wax for wax breaking effect.
- Full Grain Veg Tanned Leather

MI-1340

- 35mm Casual Belt.
- Hand Made
- Hand Finished with Natural wax for wax breaking effect.
- Full Grain Veg Tanned Leather



www.manwellindustry.com

L E A T H E R B E L T S



L E A T H E R B E L T S



MI-1342

- 35mm Casual Belt.
- Hand Made
- Hand Coloured
- Full Grain Veg Tanned Leather



MI-1343

- 35mm Casual Belt.
- Hand Made
- Hand Coloured
- Full Grain Veg Tanned Leather



www.manwellindustry.com

L E A T H E R B E L T S

L E A T H E R B E L T S



MI-1345

- 35mm Casual Belt.
- Hand Made
- Hand Coloured
- Full Grain Veg Tanned Leather

MI-1344

- 35mm Casual Polo Belt.
- Hand Made
- Hand Coloured and Hand Weaved
- Full Grain Veg Tanned Leather



www.manwellindustry.com

L E A T H E R B E L T S





MI-1346

- 35mm Casual Belt.
- Hand Made
- Hand Coloured
- Full Grain Veg Tanned Leather
- Added Design Stitch



MI-1347

- 35mm Casual Belt.
- Hand Made
- Hand Coloured
- Full Grain Veg Tanned Leather
- Added Design Stitch

www.manwellindustry.com

L E A T H E R B E L T S



MI-1349

- 35mm Casual Belt.
- Hand Made
- Hand Coloured
- Full Grain Veg Tanned Leather
- Added Design Stitch

MI-1348

- 35mm Casual Polo Belt.
- Hand Made
- Hand Coloured
- Full Grain Veg Tanned Leather



www.manwellindustry.com

L E A T H E R B E L T S





MI-1350

- 38mm Plain Casual Belt
- Hand Made
- Hand Coloured
- Full Grain Veg Tanned Leather



MI-1351

- 35mm Casual Belt
- Hand Made
- Hand Coloured
- Full Grain Veg Tanned Leather



www.manwellindustry.com

L E A T H E R B E L T S



MI-1352

- 35mm Casual Belt.
- Hand Made
- Hand Coloured
- Full Grain Veg Tanned Leather

www.manwellindustry.com

L E A T H E R B E L T S



L E A T H E R B E L T S

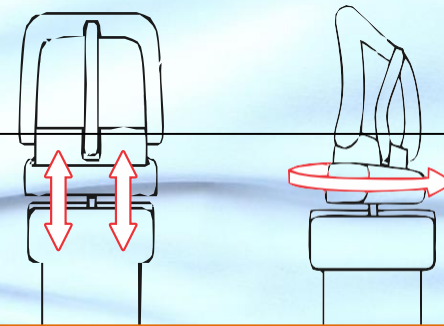

Just pull and twist the buckle to rotate the two sides

MENS FORMAL

MI-1353

- 30mm Reversible Formal Belt
- Made on Genuine Leather

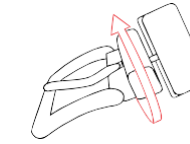

MI-1354

- 30mm Reversible Formal Belt
- Made on Genuine Leather

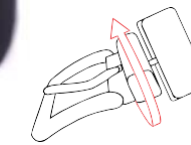

REVE SIBLE B LT

www.manwellindustry.com

L E A T H E R B E L T S

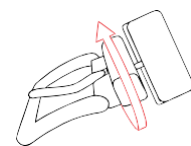

REVE SIBLE B LT

MI-1355

- 30mm Reversible Formal Belt
- Made on Genuine Leather

MI-1356

- 30mm Reversible Formal Belt
- Made on Genuine Leather

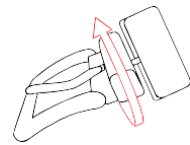

REVE SIBLE B LT

www.manwellindustry.com

L E A T H E R B E L T S



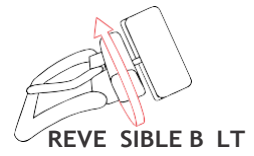

REVE SIBLE B LT



MI-1357

- 30mm Reversible Formal Belt
- Made on Genuine Leather

MI-1358

- 30mm Reversible Formal Belt
- Made on Genuine Leather

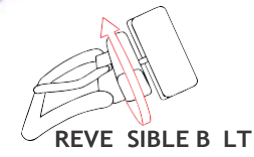

REVE SIBLE B LT

www.manwellindustry.com

L E A T H E R B E L T S



REVE SIBLE B LT



MI-1359

- 30mm Reversible Formal Belt
- Made on Genuine Leather

www.manwellindustry.com

L E A T H E R B E L T S





FEMALE CASUAL



MI-1360

- Female Studded Belt.
- Hand Made
- Hand Finished
- Full Grain Veg Tanned Leather



MI-1361

- Female Design Stitch Belt
- Hand Made
- Hand Finished And Hand Weaved
- Full Grain Veg Tanned Leather



www.manwellindustry.com

L E A T H E R B E L T S



MI-1363

- Female Plain Belt
- Hand Made
- Hand Finished
- Full Grain Veg Tanned Leather

MI-1362

- Female Plain Belt
- Hand Made
- Hand Finished
- Full Grain Veg Tanned Leather



www.manwellindustry.com

L E A T H E R B E L T S



L E A T H E R B E L T S



MI-1364

- Female Plain Belt
- Hand Made
- Hand Finished
- Full Grain Veg Tanned Leather



MI-1365

- Female Plain Belt
- Hand Made
- Hand Finished
- Full Grain Veg Tanned Leather



www.manwellindustry.com

L E A T H E R B E L T S

L E A T H E R B E L T S



MI-1367

- Female Plain Belt
- Hand Made
- Hand Finished
- Full Grain Veg Tanned Leather

MI-1366

- Female Plain Belt
- Hand Made
- Hand Finished
- Full Grain Veg Tanned Leather



www.manwellindustry.com

L E A T H E R B E L T S





MANWELL
INDUSTRY

WWW.MANWELLINDUSTRY.COM